



## Exploded views - Dial side for Calibre 2610

### Parts listed in order of assembly

1 = 53040	10 = 31083*
2 = 63012	11 = 31041
3 = 13109	12 = 3315106
4 = 33032	13 = 10062
5 = 13040	14 = 3503 (1x)
6 = 3529 (1x)	15 = 53080
7 = 31100	16 = 33011
8 = 31101	17 = 13111
9 = 53200	18 = 3503 (1x)

 Moebius SYNT HP-1300 Sans Colorant  
 Moebius 9504

**Toothing no. 12 top and bottom:**  
**\*\*\*** one drop every ten teeth

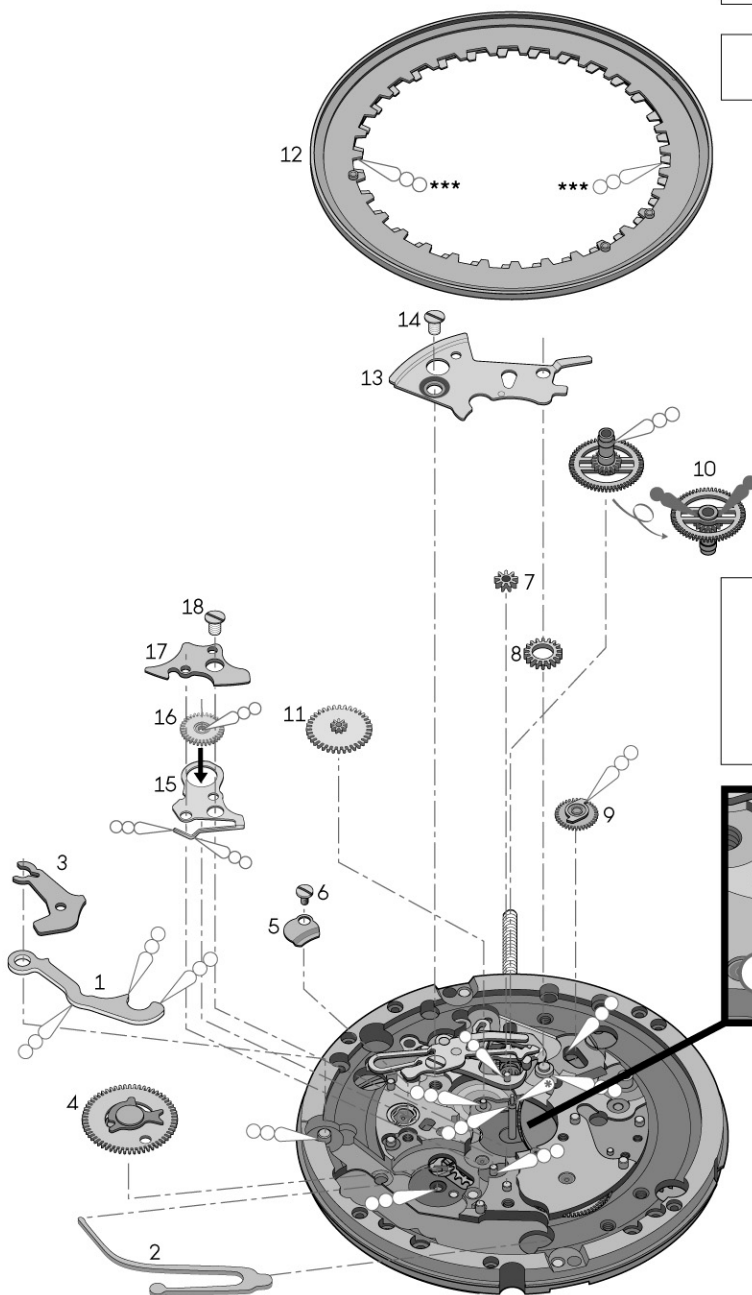

**Additional lubrication:**  
**See CS-Info Calibre no. 32**

Lubrication spot (Moebius 9010, small quantity)  
 at the exit of the second wheel axle - centre tube.

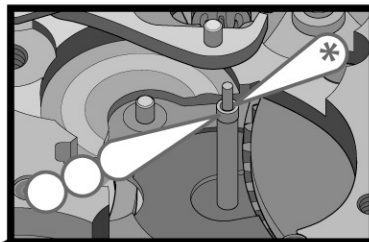

## Exploded views - Dial side for Calibre 2610

### Parts listed in order of assembly

1 = 53093	9 = 3530 (1x)
2 = 3549	10 = 33034
3 = 31046*	11 = 83170 (1x)
4 = 13108	12 = 10106
5 = 3530 (1x)	13 = 91439
6 = 53094	14 = 53250 (3x)
7 = 83170 (1x)	15 = 3528 (3x)
8 = 33035	16 = 83173 (1x)

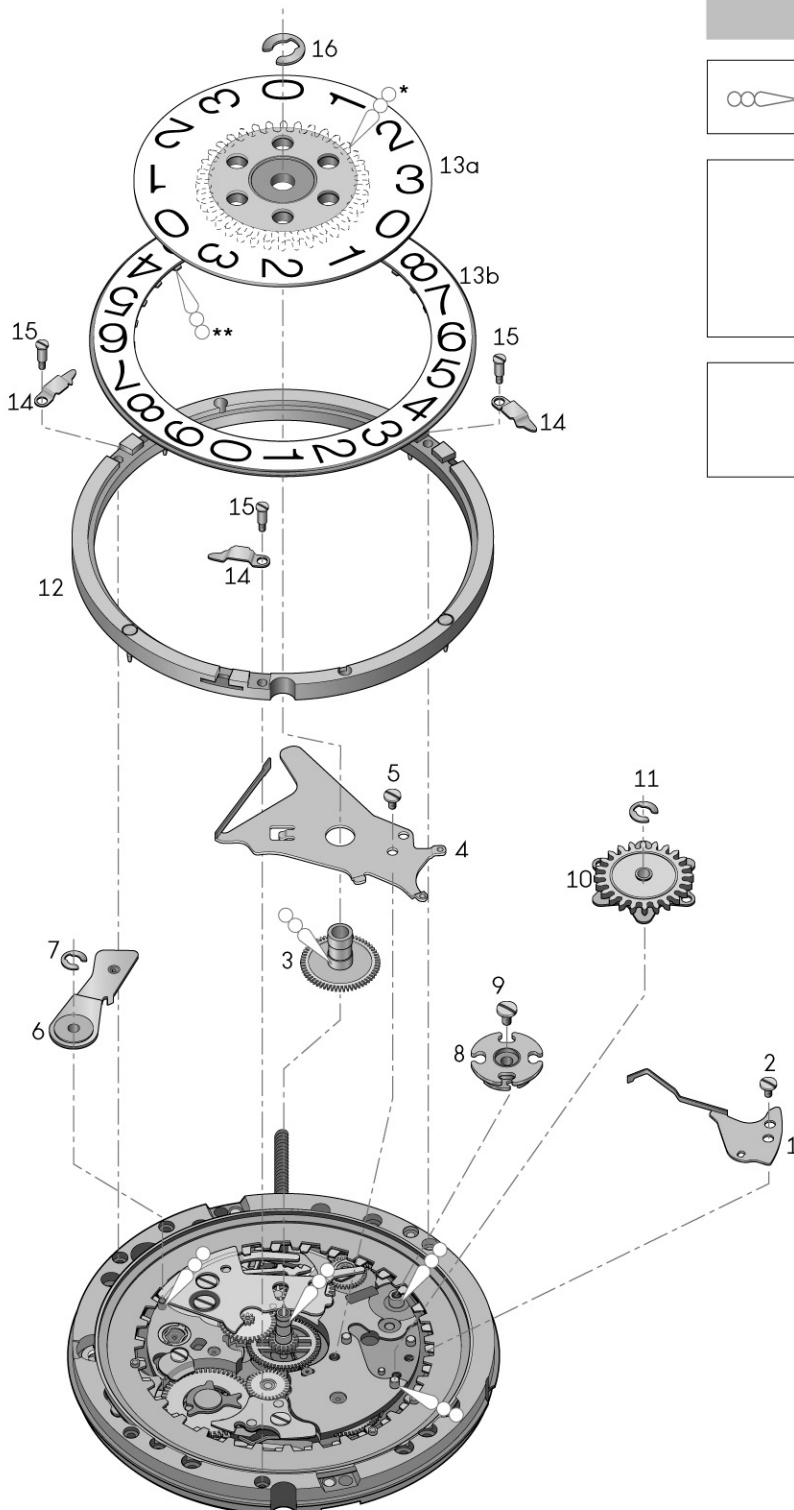

 Moebius SYNT HP-1300 Sans Colorant

#### Toothing No 13a:

\* 1 drop every 6 teeth



















#### Toothing No 13b:

\*\* 1 drop every 10 teeth





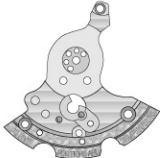



















#### Comment:

Synchronisation of units and tens indicators (see page 15).





























## Spare parts list for calibre 2610

Main plate, pre-assembled	Version	Reference	Lower automatic bridge	Version	Reference
	2610A	7222610A100207*		2610A	72211201205107
Barrel bridge, pre-assembled	Version	Reference	Reverser maintaining plate	Version	Reference
	2610A	7222610A1004107		2610A	722112012124
Wheel train bridge	Version	Reference	Intermediate date wheel bridge	Version	Reference
	2610A	7222500B1004807		2610A	7222610A13040
Pallet bridge, pre-assembled	Version	Reference	Combined maintaining plate	Version	Reference
	2610A	72225001005707		2610A	7222610A13108
Balance bridge with serial number, pre-assembled	Version	Reference	Unlocking yoke maintaining plate	Version	Reference
	2610A	7222610A10058°		2610A	7222610A13109
Minute train bridge	Version	Reference	Cam support jumper maintaining plate	Version	Reference
	2610A	722112010062		2610A	7222610A13111
Dial support	Version	Reference	Barrel complete	Version	Reference
	2610A	7222610A10106		2610A	7222500C20010
Dial fastener	Version	Reference	Barrel drum and cover	Version	Reference
	2610A	722112010300		2610A	722112020030
Upper automatic bridge	Version	Reference	Barrel arbor	Version	Reference
	2610A	7222500B1203007		2610A	722112020060



























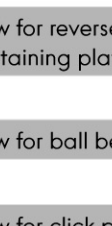

## Spare parts list for calibre 2610

Mainspring	Version	Reference	Intermediate crown wheel	Version	Reference
	2610A	7222500C20102		2610A	722112031024
Oscillating weight, pre-assembled	Version	Reference	Minute wheel	Version	Reference
	2610A	7222610A2201006		2610A	722112031041
Ball bearing	Version	Reference	Hour wheel	Version	Reference
	2610A	722112022040		2610A	7222610A31046*
Oscillating weight bolt	Version	Reference	Cannon pinion with driving wheel	Version	Reference
	2610A	722112022042		2610A	7222610A31083*
Intermediate wheel	Version	Reference	Setting wheel	Version	Reference
	2610A	722112030012		2610A	722112031100
Third wheel	Version	Reference	Intermediate setting wheel	Version	Reference
	2610A	722112030025		2610A	722112031101
Second wheel	Version	Reference	Winding pinion	Version	Reference
	2610A	7222610A30027*		2610A	722112031120
Intermediate escape wheel	Version	Reference	Sliding pinion	Version	Reference
	2610A	7222500C30039		2610A	7221120311211
Co-Axial wheel	Version	Reference	Reduction wheel	Version	Reference
	2610A	7222500C30040		2610A	722112032031
Ratchet wheel	Version	Reference	Intermediate reduction wheel	Version	Reference
	2610A	722112031020		2610A	722112032032
Intermediate ratchet wheel	Version	Reference	Ratchet driving driving wheel	Version	Reference
	2610A	722112031021		2610A	722112032033
Crown wheel	Version	Reference	Reversing wheel	Version	Reference
	2610A	722112031023		2610A	722112032037

## Spare parts list for calibre 2610

Intermediate date wheel	Version	Reference	Auxiliary reverser	Version	Reference
	2610A	7222610A33011		2610A	722112052041
Date wheel	Version	Reference	Date corrector operating lever	Version	Reference
	2610A	7222610A33032		2610A	722112053022
Tens indicator driving wheel	Version	Reference	Date unlocking yoke	Version	Reference
	2610A	7222610A33034		2610A	7222610A53040
Units indicator driving wheel	Version	Reference	Cam support jumper	Version	Reference
	2610A	7222610A33035		2610A	7222610A53080
Cam support, pre-assembled	Version	Reference	Tens jumper	Version	Reference
	2610A	7222610A3315106		2610A	7222610A53093
Pallet fork	Version	Reference	Units jumper	Version	Reference
	2610A	7222500C40010		2610A	7222610A53094
Balance complete with stud	Version	Reference	Date corrector	Version	Reference
	2610A	7222500C4005021		2610A	7222610A53200
Stud support	Version	Reference	Indicator maintaining small plate	Version	Reference
	2610A	7222500B40200		2610A	7222610A53250
Winding stem	Version	Reference	Stop lever	Version	Reference
	2610A	72211205101021		2610A	7222500C56070
Yoke	Version	Reference	Unlocking yoke spring	Version	Reference
	2610A	722112051050		2610A	7222610A63012
Setting lever	Version	Reference	Shock-absorber, upper	Version	Reference
	2610A	72211205108006		2610A	7222500C70530
Setting lever jumper	Version	Reference	Shock-absorber, lower	Version	Reference
	2610A	722112051091		2610A	7222500C70531
Click	Version	Reference	In settings, upper	Version	Reference
	2610A	722112051120		2610A	7222500C70640
Reverser	Version	Reference	In settings, lower	Version	Reference
	2610A	722112052040		2610A	7222500C70641

## Spare parts list for calibre 2610

Cap jewel, upper 	Version	Reference	Screw for wheel train bridge 	Version	Reference
	2610A	722112070900		2610A	72211203505
Cap jewel, lower 	Version	Reference	Screw for reverser maintaining plate 	Version	Reference
	2610A	722112070901		2610A	72211203506
Shock-absorber spring, upper 	Version	Reference	Screw for ball bearing 	Version	Reference
	2610A	722112078004		2610A	72211203507
Shock-absorber spring, lower 	Version	Reference	Screw for click plate 	Version	Reference
	2610A	722112078005		2610A	72211203509
Centre tube 	Version	Reference	Screw for pallet bridge 	Version	Reference
	2610A	722112080400		2610A	72225003511
Click plate 	Version	Reference	Screw for stud 	Version	Reference
	2610A	722112081036		2610A	72225003512
Tens indicator driving wheel spring-clip 	Version	Reference	Screw for dial support 	Version	Reference
	2610A	7222610A83170		2610A	7222610A3528
Units jumper spring-clip 	Version	Reference	Screw for intermediate date wheel bridge 	Version	Reference
	2610A	7222610A83170		2610A	7222610A3529
Tens indicator spring-clip 	Version	Reference	Screw for combined maintaining plate 	Version	Reference
	2610A	7222610A83173		2610A	7222610A3530
Indicator tens + unit 	Version	Reference	Screw for units indicator driving wheel 	Version	Reference
	2610A	7222610A91439*		2610A	7222610A3530
Screw for barrel bridge 	Version	Reference	Screw for tens jumper 	Version	Reference
	2610A	72211203503		2610A	7222610A3549
Screw for balance bridge 	Version	Reference			
	2610A	72211203503			
Screw for minute train bridge 	Version	Reference			
	2610A	72211203503			
Screw for automatic device framework 	Version	Reference			
	2610A	72211203503			
Screw for setting lever jumper 	Version	Reference			
	2610A	72211203503			
Screw for cam support jumper maintaining plate 	Version	Reference			
	2610A	72211203503			
Screw for lower automatic device bridge 	Version	Reference			
	2610A	72211203504			

